

Article number: 20194B45V452SW

Description: E+G

T-angel clamps GN194-B45-V45-2-SW

Measures

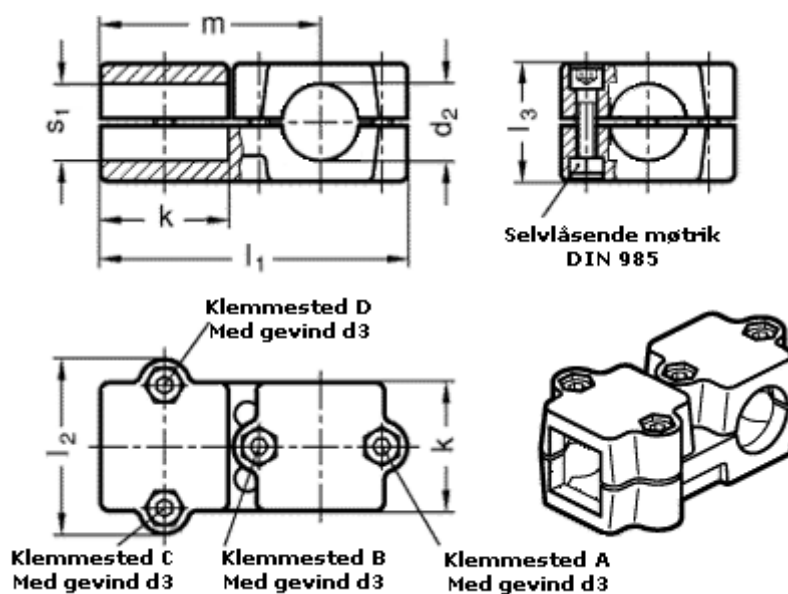

d1 = 45
d3 = M10
k = 76
l1 = 176
l2 = 98
l3 = 70
m = 126
s2 = 45